

STARIK

STAINLESS STEEL

Gegründet in der Schweiz  Founded in Switzerland

STARK Stainless Steel Motors

Foodsafe quality drives



OPERATING & MAINTENANCE INSTRUCTIONS

EBS ECONOMY SERIES IEC

EBS ECONOMY SERIES IEC

Contents

ECONOMY SERIES IEC

General info & characteristics	4
Important notes	4
Safety notes	5
Motor & type designation	5
Motor nameplate	6
Configuration type	6
Packaging, transport, delivery, storage and preparation	7
Mechanical installation	7
Electrical installation	9
Anti-condensation heater	11
Temperature monitoring elements (PTCs)	11
Frequency inverters	12
Maintenance	12
Motor drawing & parts	13





High Quality

High quality in production, sales, service and maintenance



EU-engineered

Large EU stock with short delivery times via European distribution network



Data & Support

Accurate data, R&D, testing and native support within one working day



Price & Quality

Very favorable price-to-quality ratio for all STARK Stainless Steel motors



Fast Delivery
Safe Packaging
International Distribution

EBS Economy Series IEC



Certification: CE, UL, CSA, EAC, CCC
 Power/output: 0.18 – 3kW
 IE class: IE3 ≥0,75W
 IEC size: 63 – 132
 Protection Class: IP69K
 Rating: S1 (continuous)
 Ambient temp: -15°C ~ +40°C

Material: AISI 304
 Seals: VITON/FPM
 Mounting: B14A, B14B, B5, B3
 Poles: 2-Pole, 4-Pole, 6-Pole
 Insulation class: F
 Max. altitude: 1.000 meters
 Motor protection: PTC

Voltage/Frequency: 230/400V±10%/50Hz, 265/460V±10%/60Hz
 Cooling: TENV(<0.75kW), TEFC (0.75kW – 3kW)
 Frequency Inverter (VFD): 15 – 75Hz (5 – 50Hz constant torque)
 Cable gland protection: IP68* (*IP69K cable gland on request)
 Condensation Control: anti condensation heater (230V)

IMPORTANT NOTES

Always follow the safety and warning instructions in this manual.



Electrical Hazard
 Possible consequences: Severe or fatal injuries



Hazard
 Possible consequences: Severe or fatal injuries



Hazardous situation
 Possible consequences: Slight or minor injuries



Harmful situation
 Possible consequences: Damage to the drive and the environment



Tips
 Tips and useful information

A requirement of fault-free operation and fulfilment of any rights to claim under guarantee is that you adhere to the information in the operating instructions. Consequently, read the operating instructions before you start operating the motor. Keep the operating instructions in the vicinity of the motor since they contain important information about servicing the motor.

The manufacturer disclaims all liability for consequential damages resulting from any changes or modifications made to their motors by third parties. Independent devices, such as encoders and brakes, which are attached to or placed in the motors have their own instructions for use that must be followed during installation and commissioning.

SAFETY NOTES

The following safety notes apply to the usage of stainless-steel motors.



When using geared motors please refer also to the safety notes for gearboxes in the corresponding manual.

All transport, storage, fitting, connection, installation, as well as repair and maintenance works may only be performed by qualified personnel. The installations must be installed in accordance with the locally applicable standards. The following point must be given consideration in particular:



- Corresponding detailed operating manual(s) and wiring diagrams
- Warning labels on the motor or drive
- System-specific regulations and requirements
- Relevant national/regional regulations for safety and accident prevention

Severe damage to persons and property can be caused by:



- Inappropriate usage
- Faulty installation or handling
- Impermissible removal of necessary protective covering or housing
- In particular cases the motors show surface temperatures of up to 110°C depending on design, operation and cooling. In these cases, a touch protection must be placed on the surface of the motor.

Designated use

These motors are intended for use in industrial installations; they correspond to the relevant standards and regulations and meet the requirements of the low voltage directive 2014/35/EU. The technical data and information about the relevant regulations are to be found on the nameplate and in the documentation. All instructions must be strictly observed at all times.

MOTOR AND TYPE DESIGNATION







EBS	71	L	4
Product Code	Frame Size	Frame Length	No. of Poles

MOTOR NAMEPLATE

The STARK stainless-steel motors are labelled with a laser-applied type designation. The nameplate is attached to the housing such that it can't be removed. This is done for hygienic reasons as it eliminates the possibility for contaminant accumulation and bacteria growth behind the nameplate.

								
STAINLESS STEEL 3 ~ INDUCTION MOTOR SERIES								
Type	EBS80K4	TENV	IP69K	IE3	T 155°C	Ins.Cl. F		
Hz	kW	V	%	A	rpm	cos.	Eff.	Kg
50 Δ/Y	0.55 kW	Δ230/Y400	±10	2.27/1.31	1440	0.75	82.5%/IE3	18.9
60 Δ/Y	0.55 kW	Δ265/Y460	±10	1.96/1.13	1740	0.75	81.1%	18.9

IC410	Heater 230V	Amb. temp. max. 40 °C	AISI 304
S1	P.T.C.		
Δ	W2 U2 V2 U1 V1 W1	Y	W2 U2 V2 U1 V1 W1
WASHDOWN HYGIENIC		INVERTER DUTY 5-50 Hz	

					
HOT SURFACE	IEC EN60034-1	E520837	EFFICIENCY	3 ~ Motor No.	

CONFIGURATION TYPE

The way of mounting and the position of the electric motor is also referred to as the construction form. The most common, standardized construction forms are summarized in the table below.



When choosing (ordering) the electric motor, the specified construction form must always be in accordance with the set-up (in connection with the protection class and bearing construction). If it concerns a flange motor, it is necessary to specify the desired type of mounting holes FF or FT with the corresponding M size (pitch circle mounting holes).

FF (Flange Free Holes) = through holes according to B5 flanges
 FT (Flange Tapped Holes) = tapped holes according to B14 flanges.

The configuration types of the motors can be as follows:

With feet	B3, B6, B7, B8, V5, V6
With FF flange	B5, V1, V3
With FT large flange	B14B (large B14 flange), V18, V19
With FT small flange	B14A (small B14 flange), V18, V19
With feet and FF flange	B3/B5, V1/V5, V3/V6
With feet and FF large flange	B3/B14B, V5/V18, V6/V18
With feet and FF small flange	B3/B14A, V5/V18, V6/V18

PACKAGING, TRANSPORT, DELIVERY, STORAGE AND PREPARATION

Packaging

All motors are shipped in sturdy packaging. Depending on weight, a suitable box is chosen, which may be placed on a pallet. The package is labelled with the necessary stickers.

Delivery

Please check all shipments immediately upon receipt for possible damages in transport. Before unpacking, check to ensure that the package is not damaged. Also check the motor for shipping damage. Announce these without delay to the forwarding agent and the supplier. The motors may not be used until further notice.

Transport

Avoid any tilt or upside-down transportation. If the motors are to be forwarded to the end-customer, it is recommended to use the original packaging. After acceptance of the goods at your location, the supplier can't be held liable for any damages resulting from inadequate packaging.

Storage

Avoid any tilt or upside-down storage. Do not stack too high to avoid damaging the packages underneath.

1. To minimise degradation of the insulation resistance the environment must be dry and dust-free.
2. The ambient temperature must be between -20°C and $+40^{\circ}\text{C}$, with a relative humidity of less than 70% and a maximum daily temperature fluctuation of $\pm 10^{\circ}\text{C}$.
3. To prevent damage during storage, effective vibration (V_{eff}) must not exceed 0,2 mm/s.

Preparation

After unpacking, remove dust from the motor surface and rust-preventive coating from shaft extension end. Please remove existing transport securities before use. Check, whether the data on the nameplate is correct. The fasteners should all be fixed. The rotor should not rub against the stator when it is turned by hand. Check winding insulation resistance with 500V Ohmmeter, the measured value should not be lower than $1\text{M}\Omega$, otherwise the stator winding must be dried with temperature lower than 120°C .

MECHANICAL INSTALLATION

Before installation



Live or rotating parts of electrical machines can cause serious injury or death

- Bring your installation to a complete standstill
- Completely de-energise the installation
- Take measures to protect against unintended reconnection
- Verify the absence of voltage
- Adjacent current-carrying parts must be shielded
- Follow the instructions in the installation manual
- The electrical installation must be carried out in accordance with the locally applicable regulations (e.g. correct cable diameters, cable glands, fuses, earthing cable, connection).



The motor may not be opened without the manufacturer's permission. Doing so will void the warranty. This doesn't apply to the opening of the terminal box.

During installation



Please follow the safety instructions when installing.



1. The motor may only be installed when the information on the nameplate corresponds with the mains voltage respectively the output voltage of the frequency inverter. The motor is not damaged (no damage by transport or storage).
2. The motor must only be installed in stated version on a flat, shock free and torsion tight surface.
3. The key mounted in the secondary output shaft must be secured before the electric motor is mounted, connected and started.
4. Align motor and working machine thoroughly, so that the output shafts will not be loaded inadmissibly (please note allowable radial and axial forces).
5. Make sure no shock or eccentricity occurs on shaft ends.
6. Balance parts which are drawn on shaft later with half key (motor shafts are balanced with half key).
7. Use the correct diameter mounting bolts, which must be carefully tightened and secured to prevent loosening during operation as a result of vibration and to avoid damage to the motor.
8. If the motor is installed vertically, measures must be taken to prevent small particles from falling through the fan cap, either by the way the installation is constructed or by installation of a canopy. This must not impede the flow of cooling air through the motor.
9. Pulleys or couplings may only be secured in place by means of the tapped hole in the face side of the shaft. If hammer blows are used to install pulleys or couplings on the shaft, the bearings may be irreparably damaged. Mount only carefully, dynamically balanced pulleys or couplings on the shaft end. Machines that are connected to the motor by a coupling must be aligned in accordance with the instructions provided by the coupling manufacturer.

Installation in humid environments



1. Terminal box should possibly be fixed so that the cable entries are positioned downwards.
2. Seal cable entries correctly.
3. Clean sealing surfaces of terminal box and terminal box cover well before reassembly.
4. Do not use damaged seals for cable connections and blind plugs. Replace embrittled seals.
5. STARK stainless-steel motors are suitable for use in extreme (washdown) environments such as those found in the food and pharmaceutical industries. STARK stainless-steel motors are not intended and are not intrinsically suitable for underwater use. Installation in open air, in direct sunlight will need to be carefully considered to avoid overheating.
6. Existing condensation drain holes are sealed and may only be opened when necessary. The condensation drain holes must generally be kept sealed in order to maintain the specified IP protection class. In order to counteract the effects of suction (condensation formation), each motor can be fitted with a stainless-steel breather valve. This valve is mounted on the B-bearing shield and ensures that pressure inside the motor is equal to the pressure outside the motor housing. This minimises the likelihood of condensate formation. The valve is fitted on request and is only necessary in specific applications. Please consult STARK for the use of the stainless-steel breather valve.



Please follow the safety instructions when installing.

General notes

1. Connect motors only according to the wiring diagram which is attached to the motor.
2. Do not connect or start up the motor if the wiring diagram is missing.
3. The electric motor must be earthed in accordance with local regulations.
4. The motor voltage and frequency must correspond to the local line voltage and machine load.
5. Perform connection of the motor, control circuit, overload protection and earthing in accordance with the local installation guidelines.
6. Do not use motor protection devices that automatically reset.
7. Unexpectedly starting the motor can cause serious injury or death.

Wiring notes

1. Route separately shielded feeder cables together with switched-mode power lines in one cable.
2. Do not route unshielded feeder cables together with switched-mode power lines in one cable.

Connection cable

1. Connect the electric motors with the appropriate cable and clamps. Special designs of motors may show surface temperature of up to 110°C depending on design, operation and cooling. In these cases, the operator has to fit connection cables apt for above mentioned temperature range.
2. Unused openings must be sealed with the supplied stainless-steel plugs and matching O-rings.
3. Applied wire clamps, connecting sleeves and cable glands must be suitable for the applied cable diameters.
4. Follow the recommendations in the instructions of use provided by the manufacturer of the cable and the cable glands.

Connect motor



- Please adhere to the valid wiring diagram without fail.
- When missing, the motor must not be connected or started. Qualified personnel is essential.
- Check cable cross section, as to rated power of motor, valid installations instructions and requirements on site.

Electrical connection

There are six terminals on the terminal board, the identification are as follows:

Phase sequence	A	B	C
Head of phase winding	U1	V1	W1
Tail of phase winding	U2	V2	W2

U1, V1, W1, U2, V2, W2 are the motor leads
A, B and C are the supply cables

According to the nameplate, the connection of stator winding should be delta or star. When phase sequence A.B.C. of the power supply is accord with winding sequence U1.V1.W1, motor rotate direction is C.W. as viewed from the shaft extension end. With any of these two phases of the power line changed, the motor rotates in the opposition direction.

Delta connection (Δ)

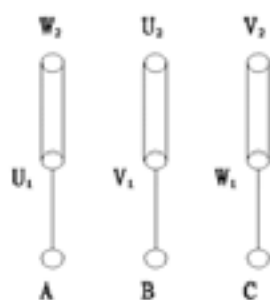

Star connection (Y)

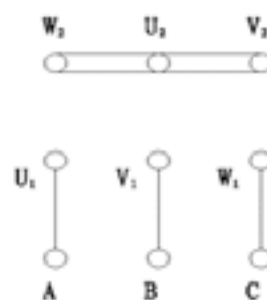

ELECTRICAL INSTALLATION

1 Remove terminal box cover. Make sure that the O-ring seal and threads will not be damaged.

2 Setup motor cables in star or delta connection according to nameplate. The black/blue marked wires are for the PTCs. The red marked wires are for the anti-condensation heater 230V.

3 Carefully remove the insulation from the earthing cable and get an eye-type cable lug suitable for the cable used, with the corresponding diameter.

4 Strip back all supply cables to a sufficient length. Attach shrink sleeve to cover completed connection thoroughly.

5 Route the cable through a suitable stainless steel cable gland into the terminal box. Check that the cable gland diameter matches the cable diameter you are using. Ensure that the assembly and connection are performed so as to maintain the protection class. If the second cable entry will not be used, it must be thoroughly sealed with the supplied stainless steel blind nut and a O-ring.

8 Connect the earth wire to the earth connection in the motor. Crimp the cable eye to the earthing cable.

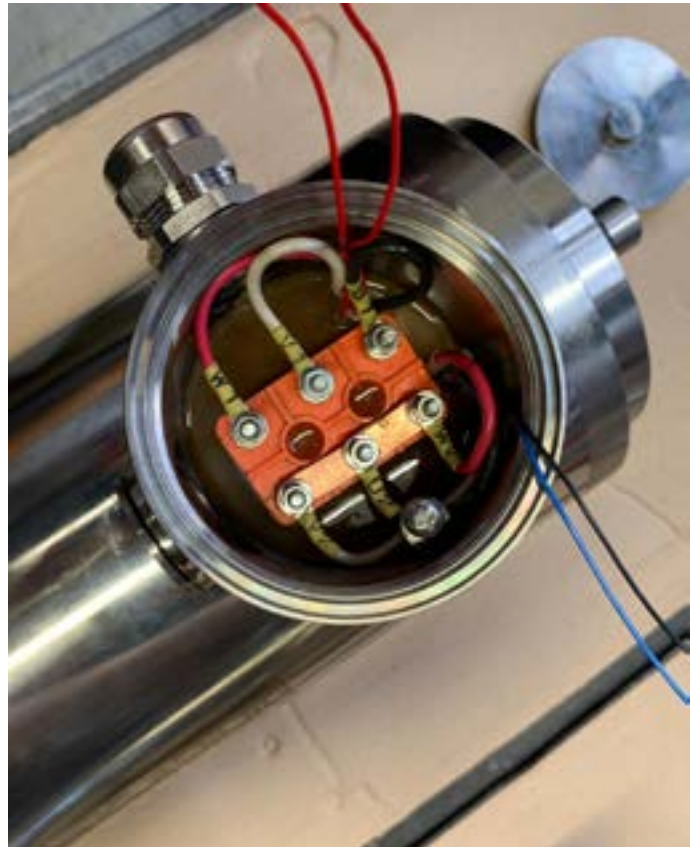

6 Connect the power cable leads to the motor terminal block in accordance with the wiring diagram.

7 Connect the built in PTC's and anticondensation heater with suitable crimp connections.

9 Lightly grease the O-ring and close the terminal box with the terminal box cover. Prevent damage to the O-ring and make sure the cover is closed firmly.

ANTI-CONDENSATION HEATER

Humidity which occurs at the windings of the motors operating especially at humid environments reduces the insulation resistance and leads to shortened motor operation life and burned windings. In such applications, humidity on the windings should be kept away from the motor by means of anticondensation heaters which are placed into the motor winding. The connection data for the anticondensation heater are listed on the nameplate. One of two different heating systems may be used:

- Heat supplied by heating elements connected to separate terminals
- Heat supplied by a winding by applying an AC voltage to terminals U1-V1

The electrical circuit must be connected so as to ensure that the motor and the anti-condensation heater are never powered at the same time:

- Motor on = anticondensation heater off
- Motor off = anticondensation heater on

Specifications:

Model	Dimensions (l*w*thickness)	Length outgoing line	Power	Rated Voltage	Rating Motor
KBQ301A	220x12x2,5x4,5 mm	160 mm	10W	220V	H63
KBQ302A	260x14x2,5x4,5 mm	340 mm	20W	220V	H71~H90
KBQ303A	350x14x2,5x4,5 mm	440 mm	30W	220V	H100~H112
KBQ304A	460x14x2,5x4,5 mm	740 mm	40W	220V	H132~H160

TEMPERATURE MONITORING ELEMENTS (PTC)

The PTC thermistors for protecting the motor windings meet the global requirements with a switching value of $TC = 155^{\circ}C$



PTC thermistors may only be operated by corresponding switching units. A connection voltage more than 2,5V can lead to destruction of the PTC thermistors and damage to the motor windings.

Type	MZ6-155-DS
Max. working voltage	30V
Normal using voltage	$\leq 2,5V$
$-20^{\circ}C \sim T_k -20^{\circ}C$	$R \leq 750\Omega$
Control temperature characteristics	$T_k -5^{\circ}C R \leq 1650\Omega$ $T_k +5^{\circ}C R \geq 3990\Omega$ $T_k +15^{\circ}C R \geq 12.000\Omega$
Normal atmospheric temp. insulation	$\geq 100M\Omega$
Voltage resistance	2500VAC/1min

The built-in PTC's are installed to monitor the maximum motor temperature and are not intended to measure the exact motor temperature. If you want to measure the exact motor temperature, the installation of PT100 or PT1000 elements is necessary.

USE OF FREQUENCY INVERTERS

All STARK stainless-steel motors are suitable for use with frequency inverters between 5 and 75Hz. For operation with frequency inverters, we recommend that the motors are protected with PTC sensors. The PTC thermal protectors (155°C) are installed by STARK as standard and are only suitable for use in control circuits and must never be connected in series with the motor.



Cable lengths more than approx. 30 meters must be avoided to prevent damage caused by harmonic peaks to the motor or frequency inverter. Consult the instructions for use of the frequency inverter used or consult your installer about the use of filters.

Basic rules when using frequency converters and STARK stainless steel electric motors:

- Above 50/60Hz the torque will decrease (see graph below)
- For uncooled motors (TENV), the set frequency should be between 20 and 75Hz
- Always consult STARK or your supplier when TENV motors are used with a frequency lower than 20Hz.
- For cooled motors (TEFC), the set frequency should be between 40Hz and 75Hz. The main reason for this is that the fan must have sufficient speed to cool the motor.

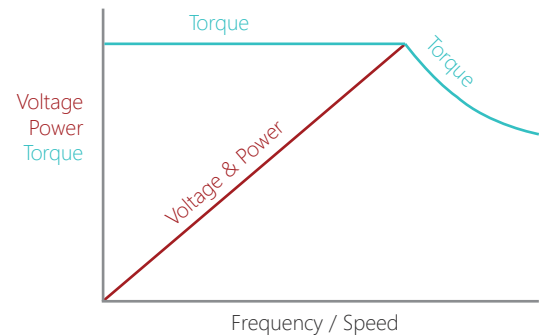

MAINTENANCE

General requirements



- Check the motors regularly, regardless of the operating conditions
- Keep the motors clean; this also applies to ventilation openings, if applicable
- Regularly check the shaft seals for damage, and replace if necessary
- Regularly check that the breather valve on the motor is working properly
- Check and retorque the mounting bolts. Make sure that the motors are firmly and correctly attached to the installation

1. Motor should be installed where atmosphere is relatively clean, dry and well ventilated
2. If the overheat protecting device or short circuit protecting device comes to function continually, judgement must be made to determine whether the motor is overloaded, or the protecting value is set too low. Only after the trouble is eliminated, the motor is allowed to resume operation.
3. The STARK stainless steel electric motors are equipped with NSK double-sided sealed deep groove ball bearings. The ball bearings are lubricated with high-temperature (-40°C / +160°C) long-life grease (ENS Grease). Under normal operating conditions the lubricant is adequate for 40.000 hours of operation for 4- and 6-pole motors and 20.000 hours for 2-pole motors.

STARK Stainless steel motors are fitted with ball bearings according to the table below.

Motor frame size	IEC 63	IEC 71	IEC 80	IEC 90	IEC 100	IEC 112	IEC 132 front	IEC 132 back
Od*bore*width (mm)	35*15*11	40*17*12	47*20*14	52*25*15	72*30*19	72*30*19	80*40*18	90*40*23
NSK Type	620ZZC3	6203ZZC3	6204ZZC3	6205ZZC3	6306ZZC3	6306ZZC3	6208ZZC3	6308ZZC3

4. Correct lubrication must be maintained during operation. Normally, bearing grease should be replaced or replenish every 2000 hours of operation (For totally enclosed bearings, no lube change is necessary during their life span). Bearing grease should be replaced when its lubricant deteriorates or when excessive heat of the bearings occurs. Before fresh grease is used, bearing and oil slot of bearing cover should be removed the dirty grease and cleaned with gasoline, then filled with lubricant, grease up to half volume (for 2 poles motors) or 2/3 volume (for 4, 6 and 8-pole motors) of the bearing inner space.
5. When the bearing is worn out, the motor vibration and noise will go up noticeably. Inspect bearing radial play, replace the

Bearing I.D. (mm)	10 - 20	20 - 30	35 - 50	55 - 80
Max. backlash allowed (mm)	0.05	0.10	0.15	0.20

MAINTENANCE

6. The fast-running secondary shaft is fitted with a special food-grade brown VITON oil seal to prevent ingress of moisture and dirt. We recommend always replacing these parts during maintenance.
7. If a fan cap is present (TEFC series), the intake and exhaust openings may not be obstructed, and the airflow may not be restricted. Reduced cooling can drastically reduce the service life of the windings. In addition, regular inspection and cleaning of the intake and exhaust openings of the fan cap is recommended. To allow optimum cooling, a minimum distance of 25% of the diameter of the air intake opening in the fan cap must be maintained between the air intake opening in the fan cap and the machine frame.
8. Dismantling and maintenance of the motor should only be carried out by authorized personnel. When disassembling the motor, take out of the rotor from the shaft extension end, and when taking the rotor from the stator, prevent damage to the stator winding or insulation.
9. To disassemble the motor, all four cap nuts on the rear shield must be loosened several turns. Several gentle taps on the cap nuts with a plastic hammer will push the front shield out of the motor housing. Once the O-ring is free of the motor housing, the shield can be pulled out of the motor together with the rotor.



It is absolutely prohibited to open the electric motor by placing a screwdriver or other sharp tool between the shield and the housing to pry them apart. Doing so will permanently damage the mating edges, making it impossible to obtain a good seal upon reassembly.

10. When replacing motor winding, correct data of winding turns, wire gauges, coil types must be recorded. In case these data are not available of costs, consult, deviation from design data will cause poor performance or completely unworkable.
11. Any inspection must be carried out using correct tools.

MOTOR DRAWING & PARTS

- | | |
|---------------------|-----------------------------|
| 1. Gland | 15. Winding stator |
| 2. O-ring | 16. Wave circle |
| 3. Cable screw plug | 17. Fan cover setting screw |
| 4. Terminal box lid | 18. End shield |
| 5. O-ring | 19. Bolt screw |
| 6. Terminal box | 20. O-ring |
| 7. Flange | 21. Washer |
| 8. O-ring | 22. Cap nut |
| 9. Oil seal | 23. Fan |
| 10. Bearing | 24. Circlips |
| 11. Hole circlip | 25. Fan cover screw |
| 12. Rotor | 26. Fan cover |
| 13. Housing | |
| 14. Feet | |

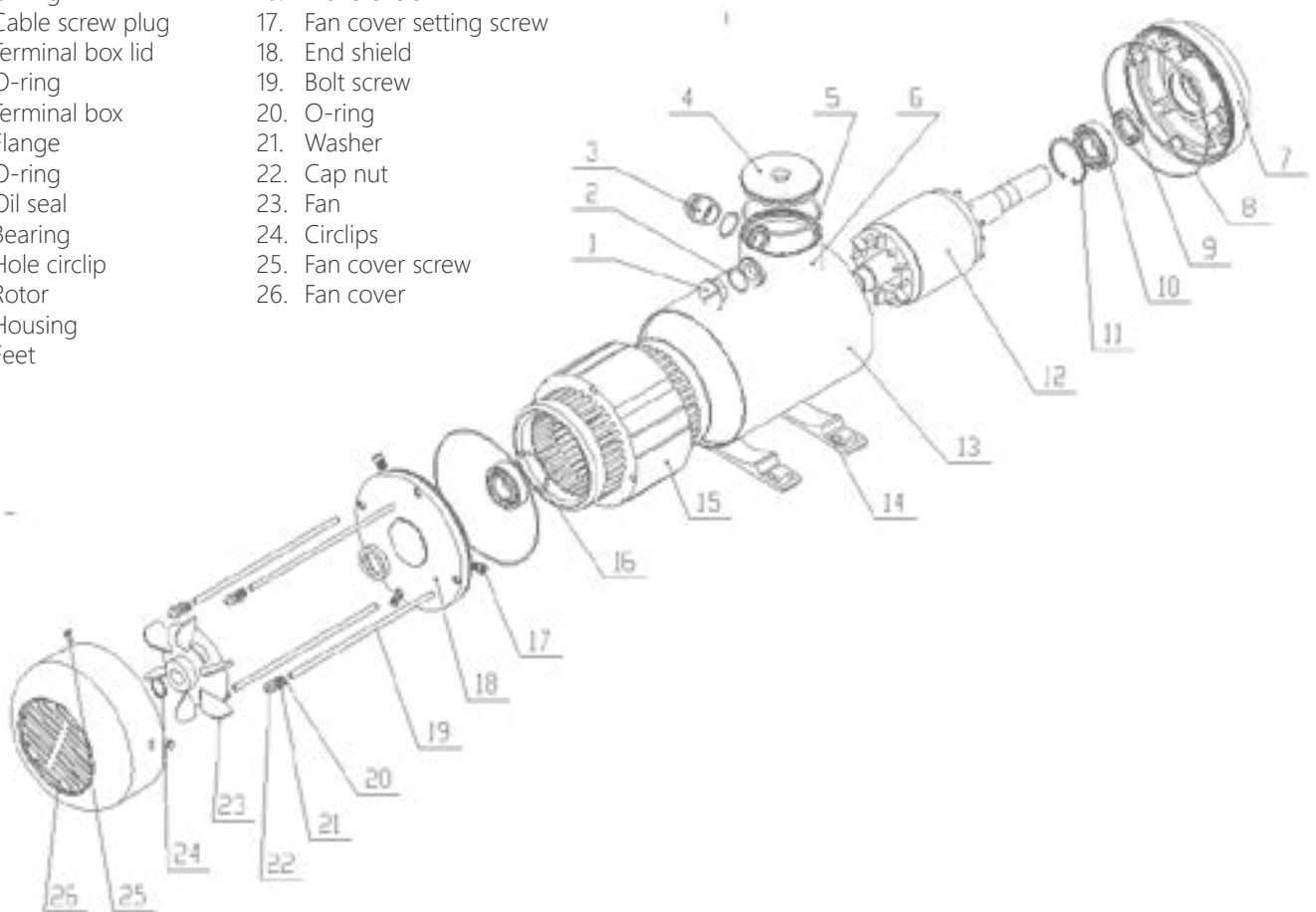

STARIK

STAINLESS STEEL

Gegründet in der Schweiz  Founded in Switzerland

Gemeinsam sind wir STARK
Together we are strong

STARK-STAINLESS-STEEL-ELECTRIC-MOTORS.COM