



Sanitation
Diaphragm
Pump

Sanitation / Energy Conservation / Reliable



BSK Fluid Technology LLC

Add: 2300 McDermott RD Ste200-336 Plano, Tx75025 U.S.A

E-mail: sales@bskfluid.com

<http://www.bskfluid.com>

SN:BSK-CN-G-202105



CONTENTS

Brief Introduction

03
—
04

- ▶ FS Sanitation
- ▶ Diaphragm Pump
 - FS50
 - FS64
 - FS77

05
—
08

- ▶ FD sanitation
- ▶ Diaphragm Pump
 - FD50
 - FD64
 - FD77
 - FD91

09
—
12

Sanitation Diaphragm Pump

BSK is committed to providing customers with high quality and reliable sanitary pumps.

The product is designed according to the relevant food hygiene standards, and the wet end parts of the pump meet the requirements of FDA standards.

Classic BSK air motor provide the pump high efficiency and reliability.

FS series pump wet end stainless steel parts by mechanical polishing, clean and beautiful (finish Ra0.8);

FD series pump wet end stainless steel parts has electrochemical polishing and mechanical polishing optional.

Self-emptying flow channel design for draining convenient. Sanitary flange with quick clamp is convenience for pump clean in place.

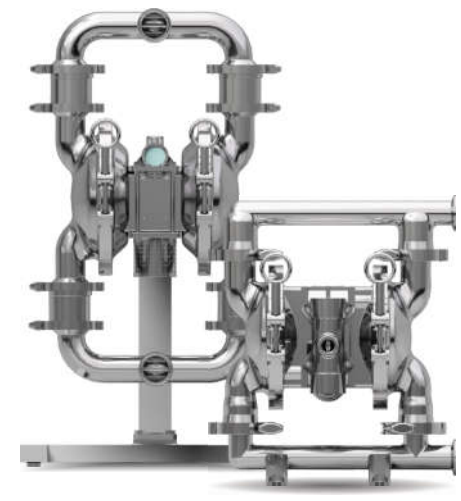

Sanitary Application

- Graphite
- Ternary material
- Nano material

- Wine
- Milk
- Ketchup
- Honey
- Chilli sauce



- Extractant
- Alcohol
- Yeast
- Culture medium

- Liquid medicine
- Ointment
- Essential oil
- Starch pulp



Sanitation Diaphragm Pump FS Series

All fluid contact materials in this pump are FDA-Compliant and meet the United States Code of Federal Regulations (CFR) Title 21, Section 177 or are of a corrosion resistant grade stainless steel. The fluid cap and manifold are made of stainless steel (SUS316) which is mechanical polishing (finish Ra0.8).

Self-Emptying Flow Channel

This design is good for draining the residual materials in the pump and do not need to remove any pump components.



Fluid cap, manifold mechanical polishing. Surface roughness is up to Ra0.8

Sanitary Flange

The quick clamp can help operator to tear down and reassembly the pump quickly. It is good for pump system cleaning. The fluid cap and manifold are made of stainless steel (SUS316) which is mechanical polishing (finish Ra0.8).



Offset Connector With Sanitary Tri-clamp

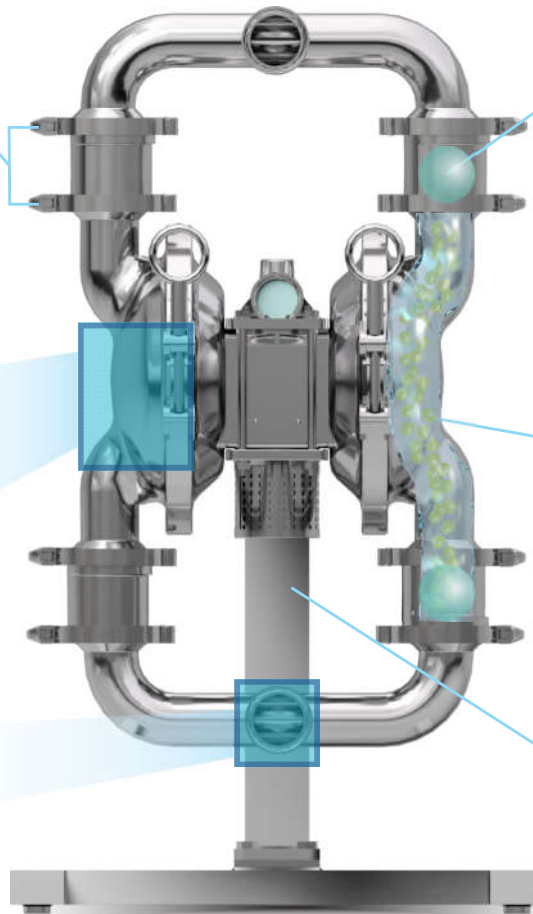

Ball Check & Flap Valve Optional

Smooth and self-emptying flow channel. Avoid pumping material residual.

Pump bracket, with rotation function for self-emptying and CIP.

Check Valve

Individual check valve design. Ball check, flap valve optional for difference material handling purpose.

	Ball Check	Flap Valve
Application	Liquid	Liquid mix granular materials
For example	Milk Ketchup Wine Honey	Poultry Seafood Canned fruit

Solids Handling Ability

The particle diameter is up to 2" maximum.

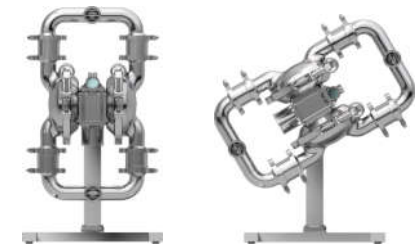

Pump bracket with rotation function. For pump up side down and clean on line easily.

FSXX-XXXX-X

- Manifold Inlet/Outlet Direction**
M – Middle S – Side
- Gasket Materials**
7 - Silicone
- Diaphragm Materials**
T - PTFE/Santoprene®
- Valve Ball Materials**
T – PTFE F – Flap check valve
- Valve Type**
B – Ball check valve F – Flap check valve
- Clamp Size**
50 – Φ50.5 64 – Φ64 77 – Φ77.5

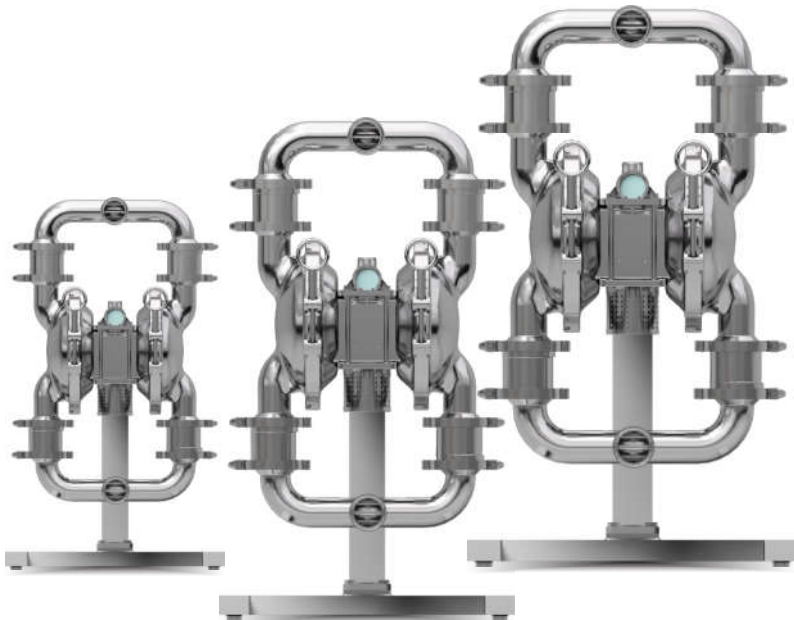

FS50-XXXX-X

Suction/Discharge Port Size	1"
Max. air inlet pressure	120 psi (8.3 bar)
Max. flow rate	178 lpm (47 gpm)
Max. suction lift – dry	6.1 m (20 ft)
Displacement / cycle	0.76 L (0.20 gal)
Max. Particle size (ball check)	12.5 mm (1/2")
Max. Particle size (flap check)	25.4 mm (1")
Noise level @ 70psi	75 dB
Weight	20 kgs (45 lbs)

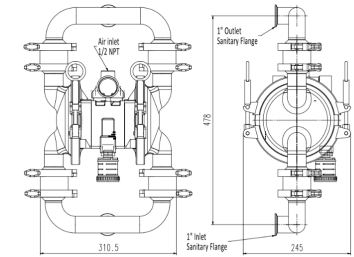

FS64-XXXX-X

Suction/Discharge Port Size	1.5"
Max. air inlet pressure	120 psi (8.3 bar)
Max. flow rate	340 lpm (90 gpm)
Max. suction lift – dry	5.3 m (17 ft)
Displacement / cycle	2.65 L (0.7 gal)
Max. Particle size (ball check)	9.5 mm (3/8")
Max. Particle size (flap check)	40 mm (1 1/2")
Noise level @ 70psi	75 dB
Weight	30 kgs (66 lbs)

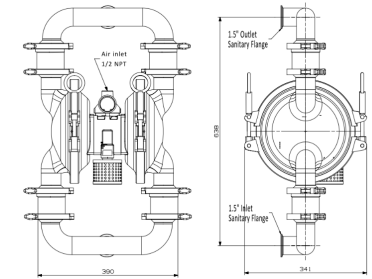

FS77-XXXX-X

Suction/Discharge Port Size	2 1/2"
Max. air inlet pressure	120 psi (8.3 bar)
Max. flow rate	621 lpm (164 gpm)
Max. suction lift – dry	5.6 m (18 ft)
Displacement / cycle	3.4 L (0.9 gal)
Max. Particle size (ball check)	9.5 mm (3/8")
Max. Particle size (flap check)	50 mm (2")
Noise level @ 70psi	75 dB
Weight	70 kgs (140 lbs)

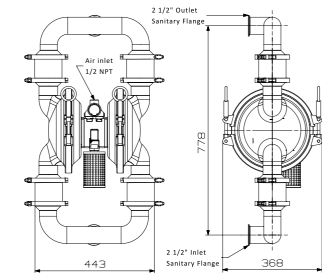



Sanitation Diaphragm Pump FD Series

All fluid contact materials in this pump are FDA-Compliant and meet the United States Code of Federal Regulations (CFR) Title 21, Section 177 or are of a corrosion resistant grade Stainless Steel. The fluid cap and manifold are made of stainless steel (SUS316). And their finish has mechanical polishing (finish Ra0.8) and electronic polishing optional. Self-empty flow channel design is good for draining the residual materials

Sanitary Flange

The quick clamp can help operator disassembly and reassembly the wetted part quickly. For pump being clean easily on line.

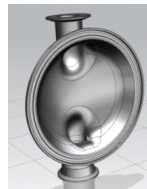

For pump disassembly/reassembly quickly and clean in place

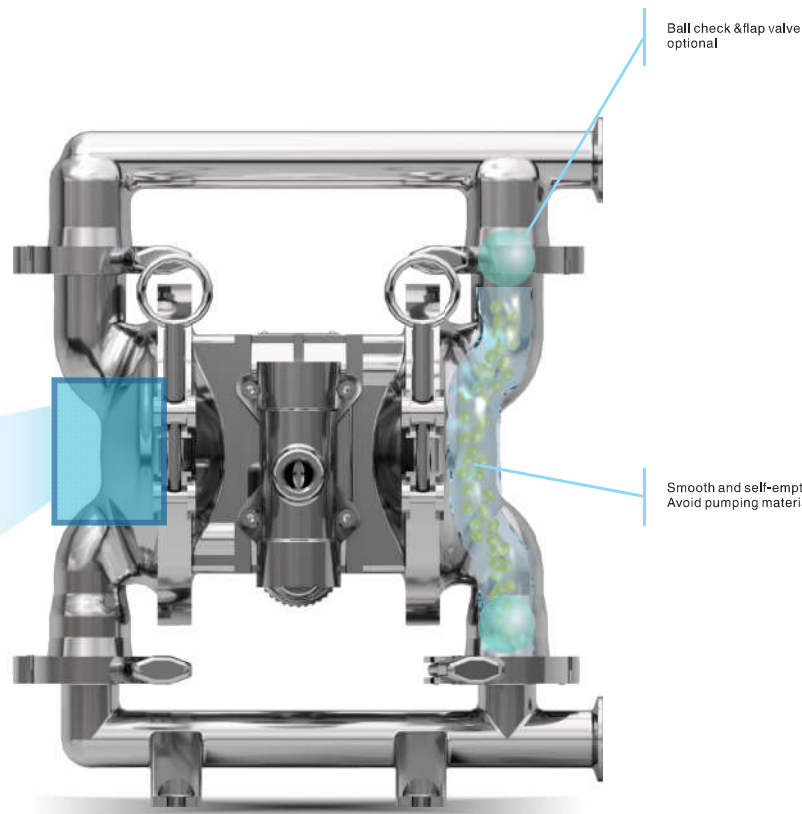

Ball check & flap valve optional

Smooth and self-emptying flow channel. Avoid pumping material residual.

Check Valve

Individual check valve design. Ball check, flap valve optional for difference material handling purpose.

	Ball Check	Flap Valve
Application	Liquid	Liquid mix granular materials
For example	Milk Ketchup Wine Honey	Poultry Seafood Canned fruit

Self-empty Flow Channel

This is good for draining the residual material.



FDXX-XXXX-X

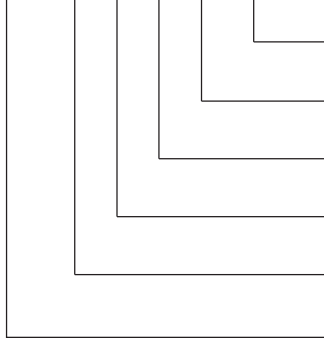

- Fluid cap & Manifold Surface Processing**
D – Mechanical polishing E – Electrochemical polishing
- Gasket Materials**
7 - Silicone
- Diaphragm Materials**
T - PTFE/Santoprene®
- Valve Ball Materials**
T – PTFE F – Flap valve
- Valve Seat Material**
S - Stainless steel F – Flap valve
- Clamp Size**
50 – Φ50.5 64 – Φ64 77 – Φ77.5 91 – Φ91

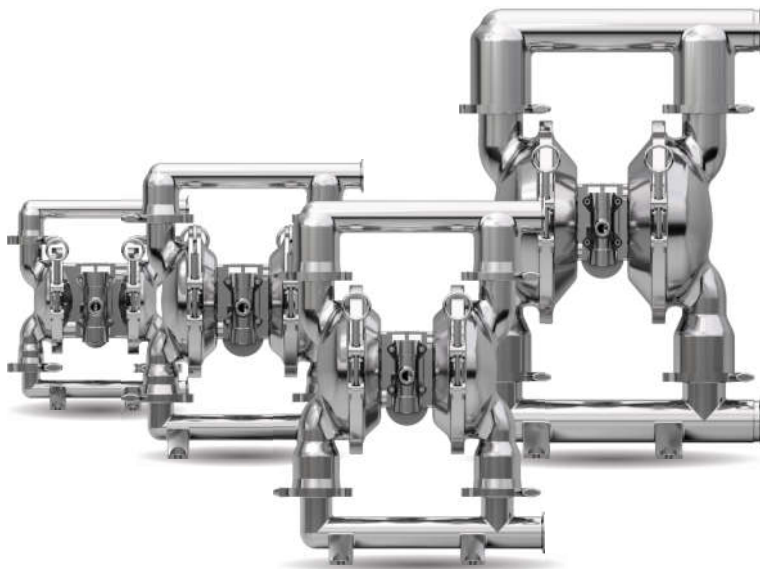

FD50-XXXX-X

Suction/Discharge Port Size	1"
Max. air inlet pressure	120 psi (8.3 bar)
Max. flow rate	178 lpm (47 gpm)
Max. suction lift – dry	6.1 m (20 ft)
Displacement / cycle	0.76 L (0.20 gal)
Max. Particle size (ball check)	4.8 mm (3/16")
Max. Particle size (flap check)	19 mm (3/4")
Noise level @70psi	75 dB
Weight	18 kgs (40 lbs)

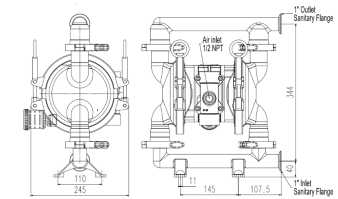

FD64-XXXX-X

Suction/Discharge Port Size	2"
Max. air inlet pressure	120 psi (8.3 bar)
Max. flow rate	340 lpm (90 gpm)
Max. suction lift – dry	5.3 m (17 ft)
Displacement / cycle	2.65 L (0.7 gal)
Max. Particle size (ball check)	8 mm (5/16")
Max. Particle size (flap check)	32 mm (1 1/4")
Noise level @70psi	75 dB
Weight	32 kgs (70.5 lbs)

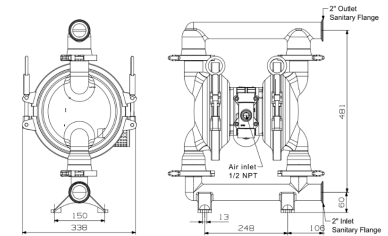

FD77-XXXX-X

Suction/Discharge Port Size	2 1/2"
Max. air inlet pressure	120 psi (8.3 bar)
Max. flow rate	621 lpm (164 gpm)
Max. suction lift – dry	5.6 m (18 ft)
Displacement / cycle	3.4 L (0.9 gal)
Max. Particle size (ball check)	9.5 mm (3/8")
Max. Particle size (flap check)	38 mm (1 1/2")
Noise level @70psi	75 dB
Weight	47 kgs (104 lbs)

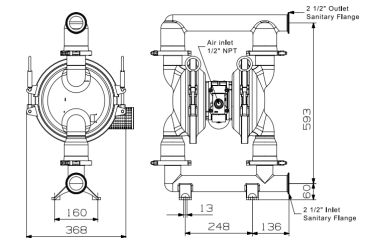

FD91-XXXX-X

Suction/Discharge Port Size	3"
Max. air inlet pressure	120 psi (8.3 bar)
Max. flow rate	880 lpm (232 gpm)
Max. suction lift – dry	4.5 m (15 ft)
Displacement / cycle	7.27 L (1.9 gal)
Max. Particle size (ball check)	12.5 mm (1/2")
Max. Particle size (flap check)	50 mm (2")
Noise level @70psi	75 dB
Weight	71.5 kgs (158 lbs)

